



上海川源机械工程有限公司
Shanghai GSD Industrial Co.,Ltd



MA/LFP submersible mixer

MA/LFP 潜水搅拌机

MA/LFP submersible mixer



低速推流器
Low-speed flow propeller



混合搅拌机(带导流罩)
Mixing agitator (With dome)



混合搅拌机
Mixing agitator

特点 Features

- 两道独立的机械密封，保证潜水电机长期可靠运行。
- 高质量国际知名品牌免维护轴承，使用寿命长。
- 独特的电缆密封设计，排除了电缆漏水的隐患。
- 电机轴采用不锈钢材质，转子经动平衡检测，运转平稳。
- 内部设有泄漏传感器和定子绕组超温保护装置（MA0.37/6、MA0.55/4无泄漏传感器）。
- 混合搅拌器的不锈钢冲压叶桨，经优化设计叶片呈后掠式，效率高，具有自清洁功能。
- 低速推流器桨叶由增强聚氨酯制成，呈后掠式，具有自清洁功能；叶桨光滑的流线型表面，使推力被平均分配。
- 低速推流器所有接触介质的紧固件均采用不锈钢材质；减速装置采用安全系数较高的一体化减速机，标配为摆线针轮减速机，可选配斜齿轮减速机。

用途 Purpose

GSD潜水搅拌机分为混合搅拌机与低速推流器，主要适用于：市政和工业污水处理过程中的混合、搅拌和环流：活性污泥池、生物反应池、搅拌池、贮泥井、均衡池、污水池等；景观水环境的养护设备，改善水体质量；创建水流，有效阻止悬浮物沉积。

The submersible mixers in our company include mixing agitator and low-speed flow propeller, mainly used for: The purposes of mixing, agitating and making ring flows in the process of municipal and industrial sewage treatment: activated sludge tank, bioreactor tank, mixing tank, sludge silos, equalizing reservoir, sewage tank and etc.; The maintenance equipment for the landscape water environment, improving the quality of the water body; Creating water flow, effectively preventing the sedimentation of the suspended substances.

- The two rows of independent mechanical sealing ensure the long-term and reliable operation of the submersible motor.
- The international well-known high-quality bearings have longer service life, which are maintenance free.
- The unique sealing design for the cables removes the hidden danger of water leakage for the cables.
- The shaft of the motor employs the stainless steel, and the rotors are inspected with the use of dynamic balancing, leading to smooth rotation.
- The in-built leakage sensor and the device for the overtemperature protection for the windings of the stator(No leakage sensor for MA0.37/6 or MA0.55/4).
- The mixer agitators have the stainless steel pressing impeller, which are of the sweptback shape through the optimized design, resulted in high efficiency and self-cleaning function.
- The vanes of the low-speed flow propeller are made of enhanced PU, which are sweptback shape, have the self-cleaning function, the smooth and streamlined propeller surface distributes the propelling power equally.
- On the low-speed flow propeller, all the tightening pieces which will contact media employ the stainless-steel material; The decelerator employs integrated reducer with high safety coefficient, whose standard configuration is CYCLO, you can also choose helical gear speed reducer.



适用条件

- 介质温度：≤40℃
- 介质pH值：5~9
- 介质密度：≤1150kg/m³
- 潜水深度：≤20m
- 电源：380V，50Hz
- 电机：F级绝缘并符合IP68，24小时连续运行
- 潜水搅拌机必须完全潜入水中工作

Conditions of usage

- The highest temperature of the media shall not exceed 40℃
- The pH value of the media: 5~9
- The density of the media shall not exceed 1150kg/m³
- The depth of submersion shall not exceed 20m
- The electric power supply: 380V, 50Hz
- The motor: F class insulation and in accordance with IP68, continuous operating in 24hr
- The submersible mixer must operate in the complete submersion into water

结构简图 Construction

不同功率结构略有不同

The structure will be different according to the power.

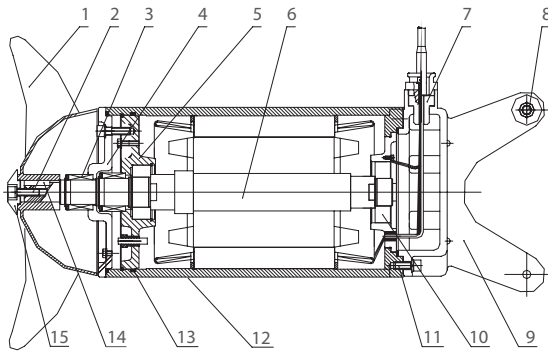

1	叶桨 Propeller	0Cr19Ni10	SUS304
2	锁紧螺钉 Lock nut	0Cr19Ni10	SUS304
3	机械密封 Mechanical seal	SiC-SiC	SiC-SiC
4	机封座 Mechanical seal stand	0Cr19Ni10	SUS304
5	前轴承座 Front bearing support	HT200	FC200
6	主轴 Main shaft	2Cr13	SUS420J1
7	水密头 Watertight head	硫化橡胶	VR
8	滚轮 Roller	0Cr19Ni10	SUS304
9	接线盒 Junction box	0Cr19Ni10	SUS304
10	轴承 Bearing	-	-
11	内六角螺钉 Inner hexagonal screw	0Cr19Ni10	SUS304
12	机壳 Sheath	0Cr19Ni10	SUS304
13	O型橡胶密封圈 O-type sealant ring	丁晴-70/NBR-70	NBR-70
14	普通平键 General flat key	45	S45C
15	叶轮压紧圈 Wheel clamp ring	0Cr19Ni10	SUS304

上表为MA标配材质，其它材质请另询！

The table above is standard material for MA type.

If other material needed, pls contact us.

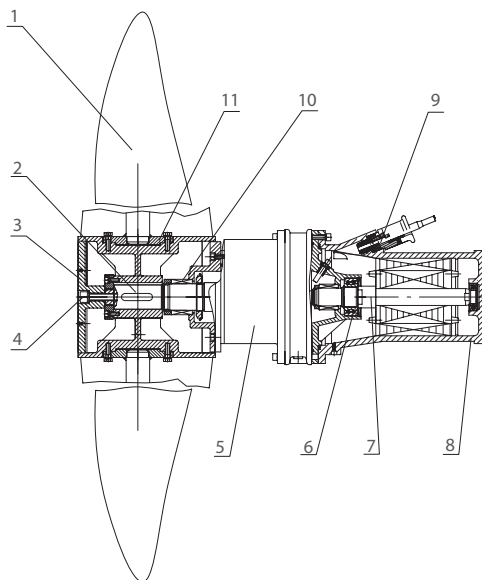

1	叶桨 Propeller	聚氨酯PU	PU
2	输出轴 Output shaft	2Cr13	SUS420J1
3	端盖 End cap	HT200	FC200
4	螺栓 Bolt	0Cr19Ni10	SUS304
5	减速机壳 Deceleration cabinet	HT200	FC200
6	轴承 Bearing	-	-
7	定子轴 Stator shaft	2Cr13	SUS420J1
8	机壳 Sheath	HT200	FC200
9	电缆密封组件 Splicing kits for power cable	-	-
10	机械密封 Mechanical sealing	SiC-SiC	SiC-SiC
11	轮毂 Wheel boss	HT200	FC200

叶桨材质可选配玻璃钢GRP材质。

You can choose GRP for the material of the propellers.

型号说明 Type description



性能参数 Performance parameters

混合搅拌器 Mixing agitator

泵型号 Pump model	电机功率 Motor power (kW)	额定电流 Rated current (A)	叶浆转速 rpm of propeller (r/min)	叶浆直径 Diameter of propeller (mm)	推力 Thrust (N)	重量 Weight (kg)
MA0.37/6-220-960	0.37	1.3	960	220	138	45/50
MA0.55/4-220-1400	0.55	1.6	1400	220	145	45/50
MA0.85/8-260-740	0.85	3.2	740	260	163	55/65
MA1.5/6-260-960	1.5	4	960	260	290	55/65
MA2.2/8-320-740	2.2	5.9	740	320	582	88/93
MA4/6-320-960	4	10.3	960	320	609	88/93
MA1.5/8-400-740	1.5	5.2	740	400	600	74/82
MA2.5/8-400-740	2.5	7	740	400	800	74/82
MA3/8-400-740	3	8.6	740	400	920	74/82
MA4/6-400-960	4	10.3	960	400	1200	74/82
MA4/12-620-480	4	14	480	620	1400	190/206
MA5/12-620-480	5	18.2	480	620	1800	196/212
MA7.5/12-620-480	7.5	28	480	620	2600	240/256
MA10/12-620-480	10	32	480	620	3300	250/266

注：1、上表“重量”一栏分别表示不带导流罩和含导流罩的重量。
In the above table, the value listed in the column of "weight" respectively contains the weight of without or with the dome.
2、叶浆直径220mm的混合搅拌器叶浆为二叶片式，其余均为三叶片式。
Mixer agitator whose propeller diameter 220mm has two vanes, other has three vanes.

低速推流器 Low-speed flow propeller

泵型号 Pump model	电机功率 Motor power (kW)	额定电流 Rated current (A)	叶浆转速 rpm of propeller (r/min)	叶浆直径 Diameter of propeller (mm)	推力 Thrust (N)	重量 Weight (kg)
LFP1.5/4-1100-52	1.5	4	52	1100	860	215
LFP2.2/4-1100-63	2.2	4.9	63	1100	1260	215
LFP3/4-1100-85	3	6.8	85	1100	1790	215
LFP2.2/4-1800-34	2.2	4.9	34	1800	2380	230
LFP3/4-1800-42	3	6.8	42	1800	2540	230
LFP3/4-2500-34	3	6.8	34	2500	3200	260
LFP4/4-2500-42	4	9	42	2500	3420	260

注：低速推流器叶浆为二叶片式。
Low-speed flow propeller has two vanes.



流场图 Diagrams of the flow field

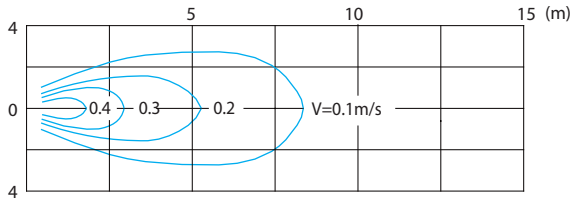

MA0.37/6-220-960

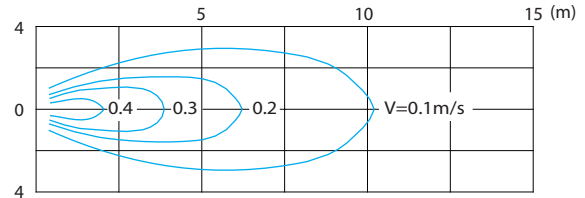

MA0.55/4-220-1400

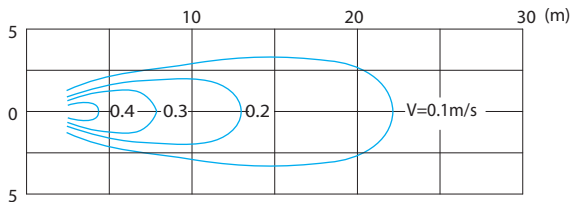

MA0.85/8-260-740

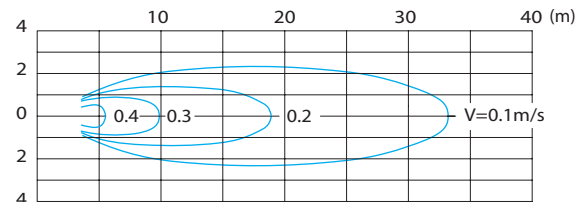

MA1.5/6-260-960

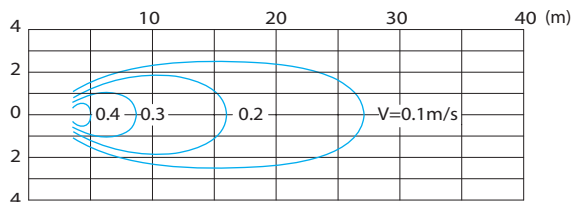

MA1.5/8-400-740

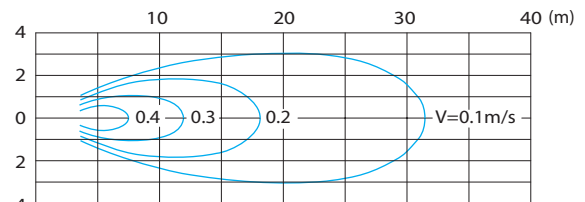

MA2.2/8-320-740

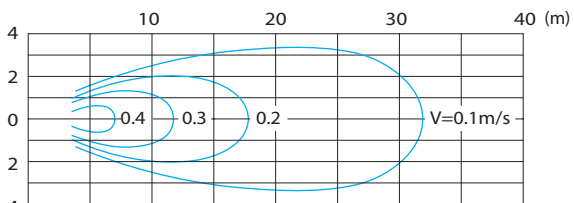

MA2.5/8-400-740

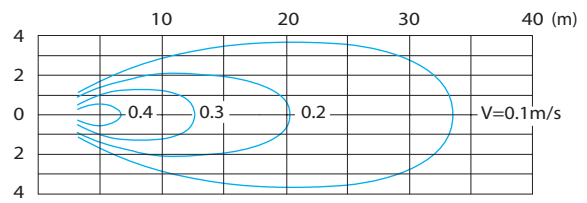

MA3/8-400-740

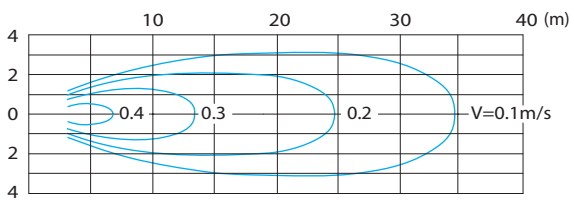

MA4/6-320-960

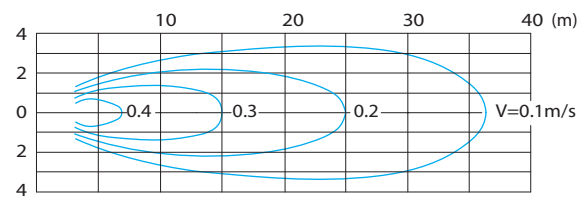

MA4/6-400-960

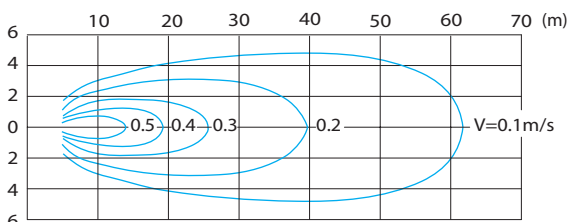

MA4/12-620-480

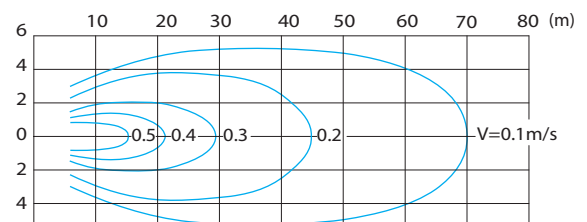

MA5/12-620-480

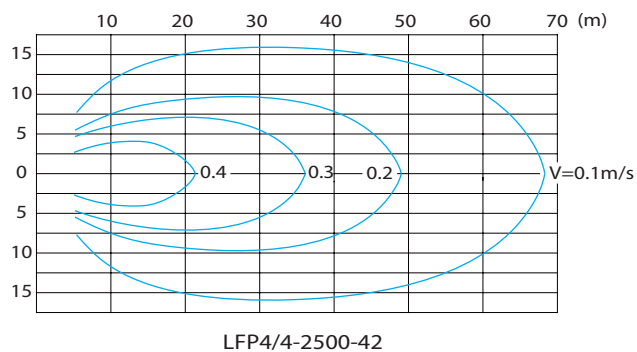
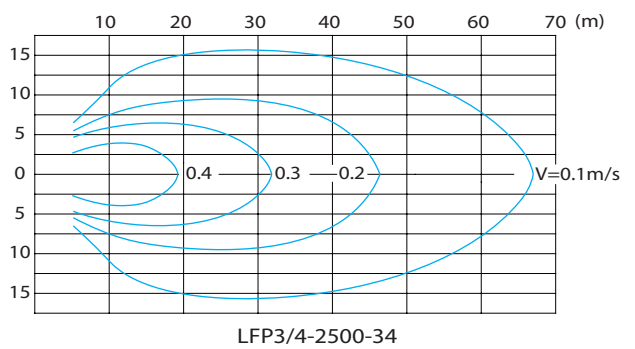
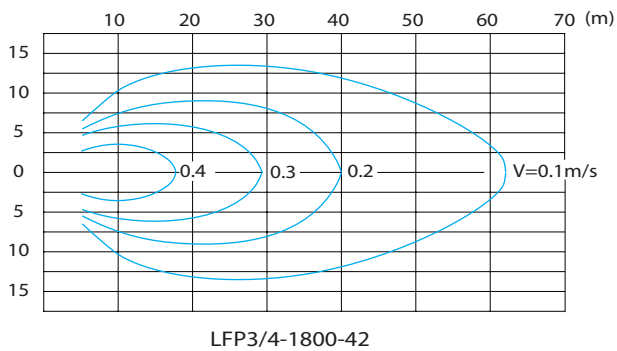
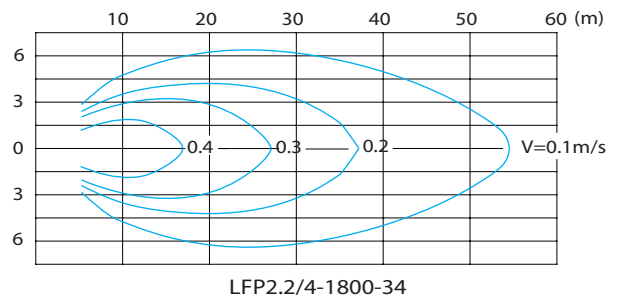
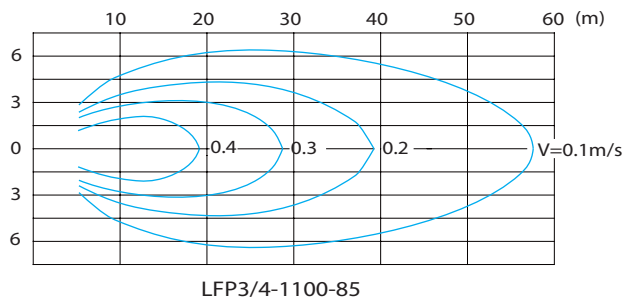
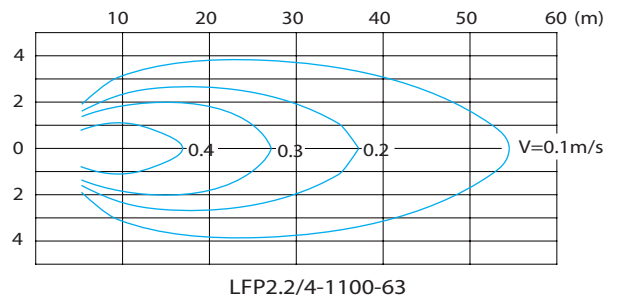
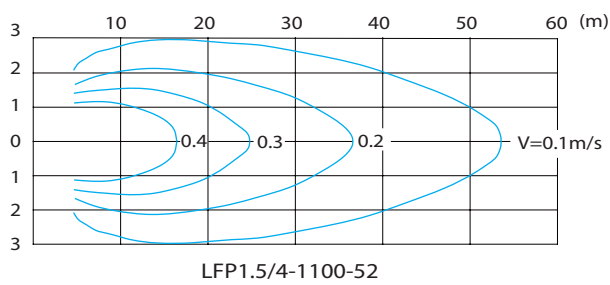
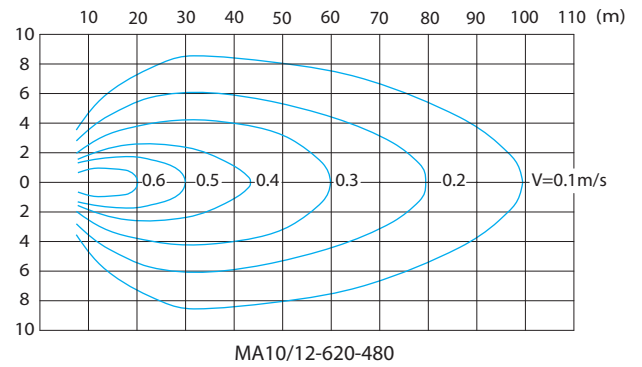
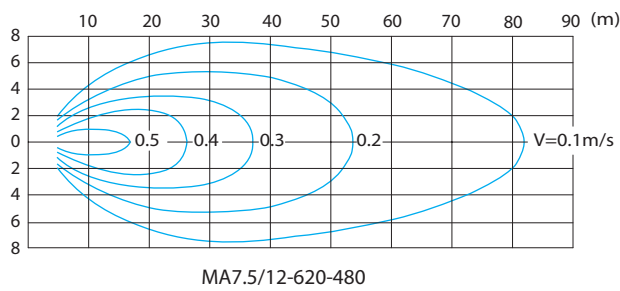

安装方式及尺寸

潜水搅拌机可以有多种安装方式，这里提供四种最通用的方式供选择，尺寸可参考下表。我公司还可以根据用户的要求作特殊设计。

型号 Type	a	D	b	L	H _{1min}	H _{2min}	安装系统 Installation system
MA0.37/6-220-960	∅40/□50	340	330/235	520/960	500/800	110/150	I/II
MA0.55/4-220-1400	∅40/□50	340	330/235	520/960	500/800	110/150	I/II
MA0.85/8-260-740	∅48/□50	360	330/235	630/960	500/800	110/150	I/II
MA1.5/6-260-960	∅48/□50	360	330/235	630/960	500/800	110/150	I/II
MA2.2/8-320-740	□70	460	320	970	800	150	II
MA4/6-320-960	□70	460	320	970	800	150	II
MA1.5/8-400-740	□70	530	320	960	800	200	II
MA2.5/8-400-740	□70	530	320	960	800	200	II
MA3/8-400-740	□70	530	320	1010	800	200	II
MA4/6-400-960	□70	530	320	1010	800	300	II
MA4/12-620-480	□100	760	335	1150	1100	300	III
MA5/12-620-480	□100	760	335	1150	1100	300	III
MA7.5/12-620-480	□100	760	335	1280	1500	300	III
MA10/12-620-480	□100	760	335	1280	1500	300	III
LFP1.5/4-1100-52	□100	1100	200	1130	1000	270	IV
LFP2.2/4-1100-63	□100	1100	200	1130	1000	270	IV
LFP3/4-1100-85	□100	1100	200	1130	1000	270	IV
LFP2.2/4-1800-34	□100	1800	200	1150	800	125	IV
LFP3/4-1800-42	□100	1800	200	1150	800	125	IV
LFP3/4-2500-34	□100	2500	200	1150	1000	125	IV
LFP4/4-2500-42	□100	2500	200	1200	1000	125	IV

注：

- 潜水搅拌机的专用安装系统，可在无需排出池中污水的情况下，快速安装和拆卸潜水搅拌机。
- 安装系统 I 只适用 $H \leq 3m$ ，机型为 MA0.37/6、MA0.55/4、MA0.85/8 和 MA1.5/6，可在水平方向和垂直方向调节角度。
- 安装系统 II、III 导杆可沿水平方向绕导杆轴线旋转，最大转角为 $\pm 60^\circ$ ，当 $H > 4m$ 时需在导杆中间添加一支撑架。
- 支撑架和下托架与池壁、池底均可用膨胀螺栓或化学锚栓固定，对于大直径叶轮和大功率搅拌机最好采用预埋。
- 客户订货时，请提供池深 H 及池型图，以便确定导杆尺寸和支撑架个数。
- 同一种安装系统，多台搅拌机可共用一套起吊系统。
- 安装系统可选择采用不锈钢或碳钢防腐材质。

Installation modes and dimensions

The submersible mixers can be installed in a multiple of modes. Here are four generally accepted modes of installation for selection with reference made to the following table. Our company can also provide the special designs in accordance with the demand of the users.

Notes:

- The special installation systems for the submersible mixers can facilitate the quick installation and dismantling of the submersible mixers under the conditions of no need for draining off sewage from the pond.
- Installation System I is only suitable for $H \leq 3m$ and the mixer models of MA0.37/6, MA0.55/4, MA0.85/8 and MA1.5/6, and with the possibility of adjusting the angles in both horizontal direction and longitudinal direction.
- For installation systems II and III, the guide rod can rotate round the axial line of the guide rod along the horizontal direction with the maximum angle of rotation $\pm 60^\circ$, if $H > 4m$, it is necessary to add a supporting frame between the guide rods.
- The supporting frame and the lower support shall be fixed onto the pond wall and the pond bottom with the use of expansion bolts or chemical anchors. For the big diameter impellers and the big power mixers the best choice is to pre-embed.
- While placing an order by customer. Please supply the pond depth H and the drawing of the pond shape so as to determine the dimensions of the guide rod and the number of the supporting frames.
- A multiple of mixers with the same installation system can share one lifting system.
- The installation systems may employ the material of stainless steel or carbon steel for the selection of the corrosion-resisting properties.



外形及安装尺寸 Installation dimensions

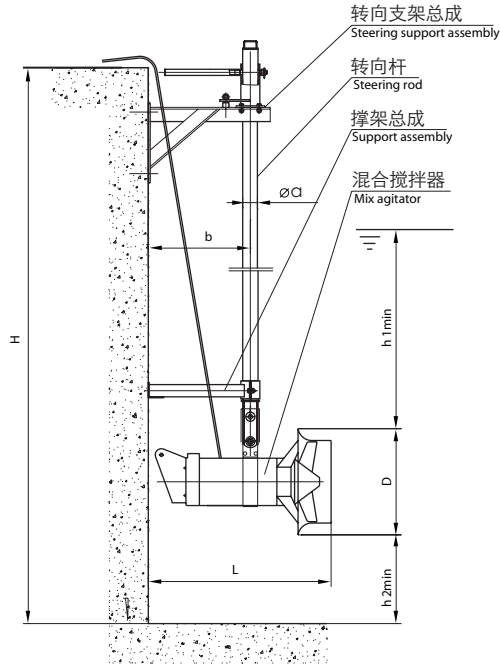

System I

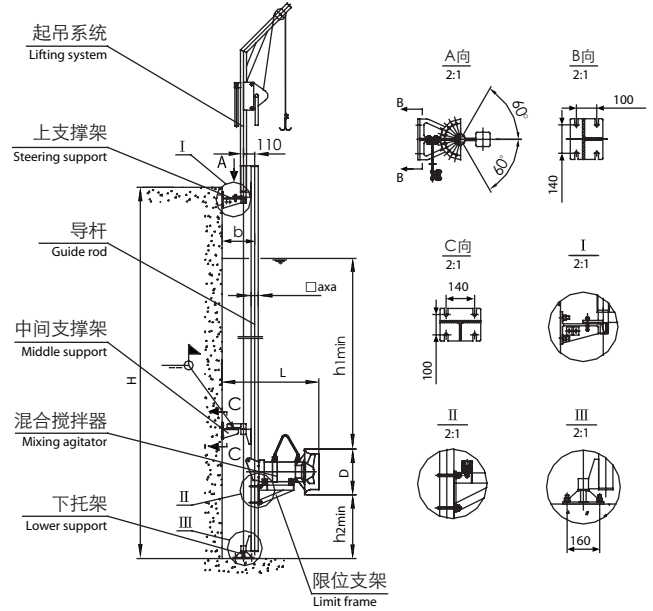

System II

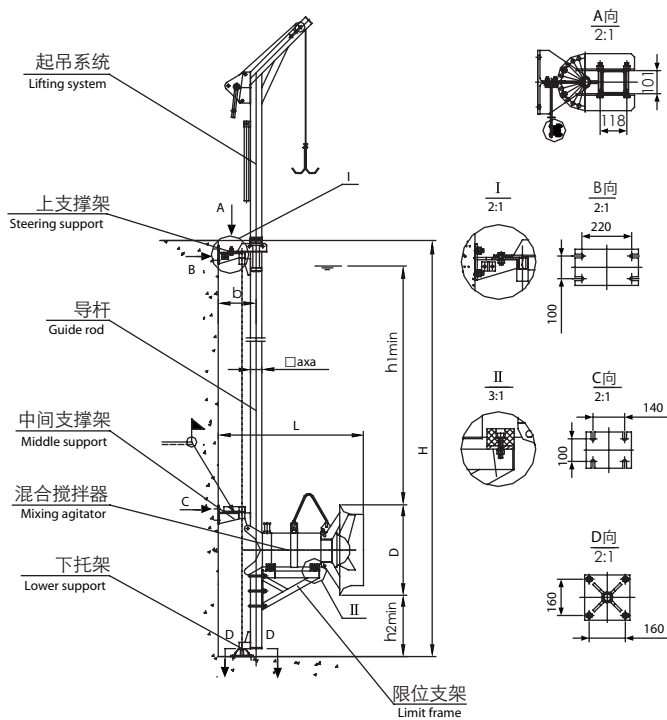

System III

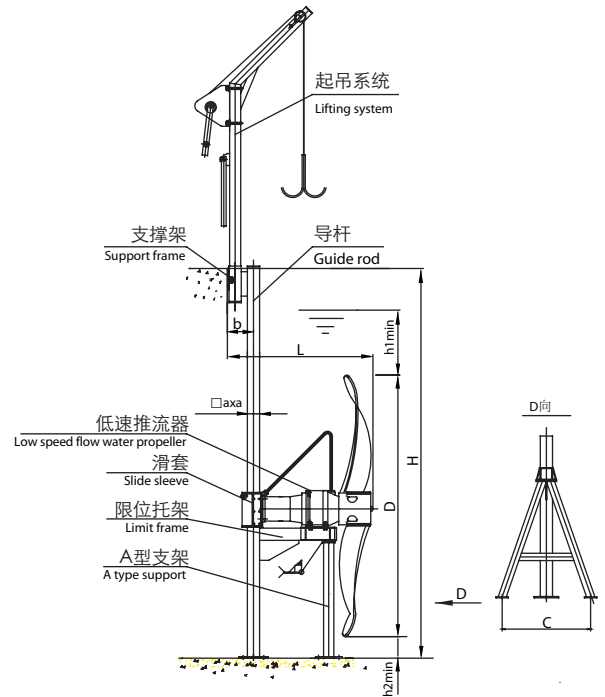

System IV



配置示意图

潜水搅拌机的安装定位对其搅拌效果有很大的影响，为了达到良好的运行效果，我们建议用户按照专业设计人员的要求去做，要充分考虑到水池的形状，进出水的位置以及搅拌机的水流反射到构筑物而引起的涡流等情况，尽量减少短路循环和死角的产生，避免与池壁的撞击而降低流速。参照下面的配置示意图，可帮助您合理选择搅拌机和安装型式。

Arranging sketch map

The installation and positioning of the submersible mixers will produce a great impact on the effect of mixing. In order to obtain the perfect operating result, it is suggested that the advice of the specialized designers shall be followed and full consideration given to the shape of the pond, position of the water inlet and outlet, the vortex resulting from the outflow from the mixer onto the structures and some other conditions. Every effort shall be made to reduce the short-circuit circulation and the occurrence of dead corners and avoid the dashing of the flow against the pond wall for lowering the flow velocity. Making reference to the arranging sketch map below will help you to make a reasonable selection of the mixers and their installation modes.

混合搅拌器 Mixing agitator

避免短路循环
Avoid short circuit flows

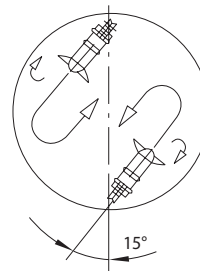
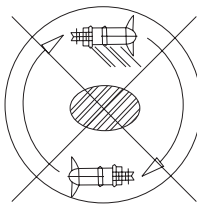

考虑进出口
Take inlet and outlet into account

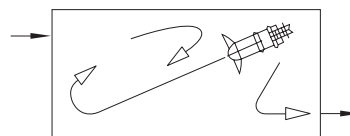
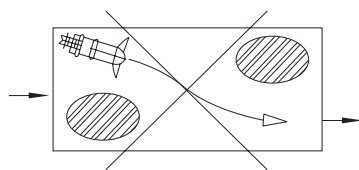

考虑喷射流范围，避免与池壁发生不必要的冲撞
Take jet expansion into account, no unnecessary wall friction

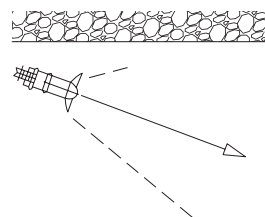
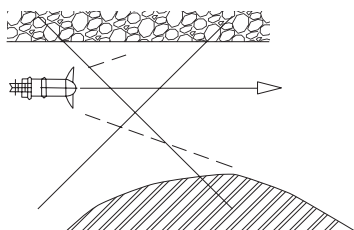

安装引起的死区

Installations cause dead zones

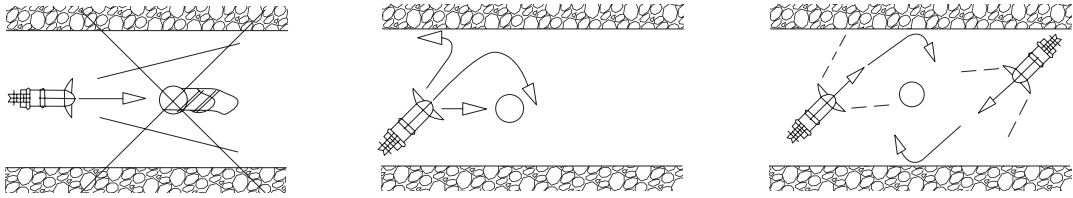

喷射流的交叉

Jet intersections

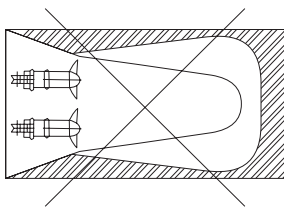

考虑到恒一能量的供应

Take uniform energy supply into account

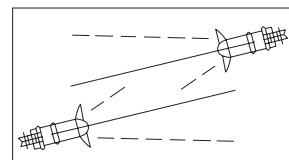

利用池壁反射

Use wall reflections

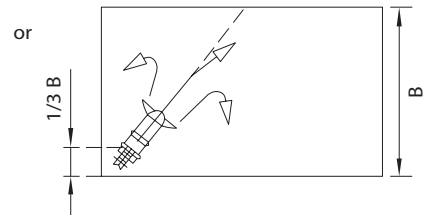
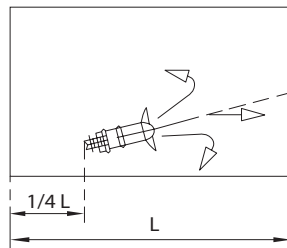
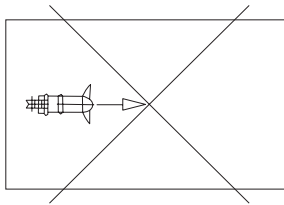

低速推流器 Low-speed flow propeller

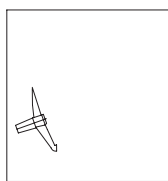

方形池 Square pond

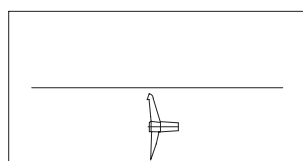

矩形池 Rectangular pond

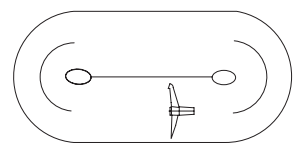

跑道形池 Track-shaped pond

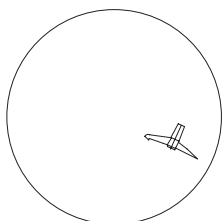

圆形池 Circular pond

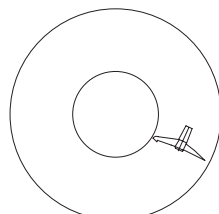

环行池 Ring-shaped pond

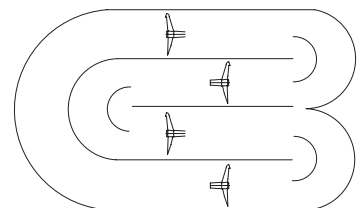



S曲线形池 S-shaped pond

如蒙洽询请指示下列各项
For further details, please fulfill the chart below.

客户 _____ 承办人员 _____
Customer _____ Undertaker _____

工程名称 _____ 工程地点 _____
Name of project _____ Address of project _____

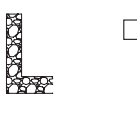
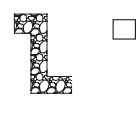
电话 _____ 传真 _____
Telephone _____ Fax _____

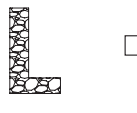
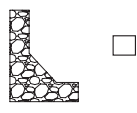
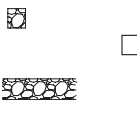
基本选型参数 Basic parameters	*工艺名称 Processes name	氧化沟 Oxidation ditch	<input type="checkbox"/>	A-O法 A-O	<input type="checkbox"/>	SBR法 SBR	<input type="checkbox"/>	其它(注) Others			
	*安装位置 Installation location	其它(注) Others									
	*基本池型(m) Pond form	长 L	宽 W	深 H	长 L	宽 W	深 H	长 L	宽 W	深 H	
	*有效水深(m) Available water depth										
介质参数 Media parameter	介质名称 Name						密度 Density				
	主要成分 Main composition						* PH 值 PH				
	*温度 Temperature						黏度 Viscosity				
	其它 Other										
工艺要求参数 Technique parameters	*主要搅拌混合方式 Mixing methods	搅拌型 Mixing agitator	<input type="checkbox"/>	推流型 Flow propeller	<input type="checkbox"/>	其它(注) Other					
	*池底最低流速(m/s) Minimum flow speed at the bottom										
	其它工艺要求 Other requests										
池形结构 Pool structure	*池沿结构 Pool surface structure		<input type="checkbox"/>		<input type="checkbox"/>		<input type="checkbox"/>	其它 Others			
	*池底结构 Pool bottom structure		<input type="checkbox"/>		<input type="checkbox"/>		<input type="checkbox"/>	其它 Others			
材质要求 Material requests	主机壳体 Sheall body						*水下导杆及支座 Guide and support				
	搅拌叶浆 Mixing propeller						*水上吊架及支座 Hanger and support				
	导流罩(是否需要) Fairwater(need or not)						*螺栓、螺母及垫圈 Bolt, nut and gasket				
	主轴 Main shaft						*提升钢丝绳 Boom hoist cable				
搅拌机结构性能参数 The machine parameters	传动方式 Driving method						电机功率(kW) Motor power				
	密封形式 Seal type						额定电流(A) Rated current				
	叶轮直径(mm) Propeller diameter						电源 Power				
	叶轮转速(rpm) Propeller speed						防护等级 Protection grade				
	推力(N) Thrust						工作制式 Working standard				
其它要求 Others											

注：为准确选型，项目前加注“*”号者，请务必详加填写。
Note: In order to choose the right type, the item with "*" should be filled as detail as possible.

欢迎索取以下产品型录



泵系列

- 潜水泵系列
- 陆上泵系列
- 特种泵系列
- 消防泵系列



搅拌推流系列

- 搅拌机系列
- 推流器系列



供氧曝气系列

- 曝气机系列
- 曝气盘系列
- 曝气管系列



风机系列

- 三叶罗茨鼓风机系列
- 增压罗茨鼓风机系列



污泥处理设备 及其他

- 固液分离系列
- 泡药设备
- 输送设备



上海川源机械工程有限公司
Shanghai GSD Industrial Co., Ltd

免费咨询电话

800-820-1977

本型录内容如有变更，恕不另行通知。
We reserve the right to change content without notice.

CY-B9